

This Quick Installation Manual explains basic details to install GSM based TrackSo Data Logger WT405 M - RS485

Electrical equipment should be installed, operated, serviced, and maintained only by qualified personnel. No responsibility is assumed by TrackSo for any consequences arising out of the use of this material. A qualified person is one who has skills and knowledge related to the installation and operation of electrical equipment and has received safety training to recognize and avoid the hazards involved. The equipment MUST NOT be used by inexperienced staff. TrackSo shall not be liable for any damages whatsoever that may result from incorrect or careless operation.

Before attempting installation kindly insure you have understood the installation process and device functioning. In case of any queries kindly reach us at support@trackso.in

Tools and Materials Needed



2 & 4 Core RS485 Wire for Modbus-RS-485 Connections

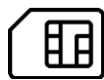

Sim with SMS & Internet Connectivity



Multi Meter



Screw Driver



Allen Key Set

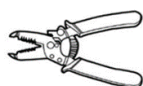

Wire Stripper



Pliers



Saddle Clips

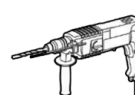

Hammer Drill

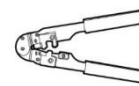

RJ45 Crimping Tool & CAT6 Wire



Laptop With Internet Connectivity

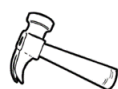

Hammer

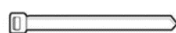

Cable Ties



Surge Protection SPD's



UPS for Power Backup (Optional)

Steps for Installation

Overview of steps involved in installation:

- Step 1:** Create basic single line diagram of your plant on a paper and identify the material required for your site.
- Step 2:** Arrange all the necessary material & tools required for the installation
- Step 3:** Complete the physical installation of all the equipment's. (Datalogger, SPD's, UPS etc)
- Step 4:** Insert a SIM Card with SMS & Internet connectivity in data logger. Verify you are able to receive response from logger via SMS as per SMS Commands mentioned on page 3
- Step 5:** Connect data logger to the required Modbus RTU RS485 based equipment's (Inverter/MFM Meter/WMS/SMB)
- Step 6:** Complete Modbus Settings of all the equipment's – Set Unique Modbus Address (Id) , Baud Rate etc. as per Connection Manual
- Step 7:** If opted for Analog Sensors, connect them on analog ports as per the manual supplied.
- Step 8:** Login on TrackSo Platform at trackso.in & Verify the Site Status (Online / Offline / ON-ERR)
- Step 9:** If any of the required unit is not Active on platform re-verify connection/settings as per Connection Manual

Sample Connection Diagram

Sample diagram -Connecting 1 Modbus RTU RS485 based equipment's (Inverter/MFM Meter/WMS/SMB)

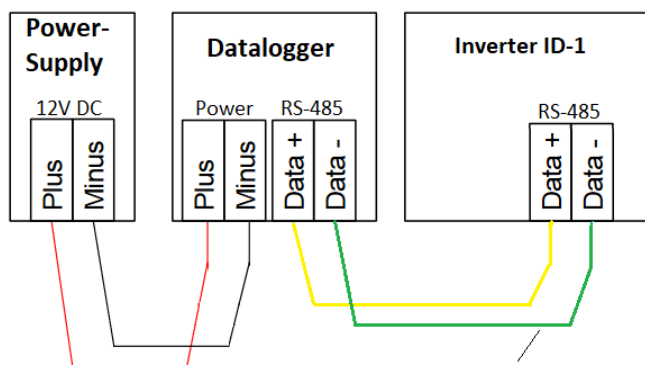

Shielded RS485 Cable. Max Length- 1000m

Pinout details

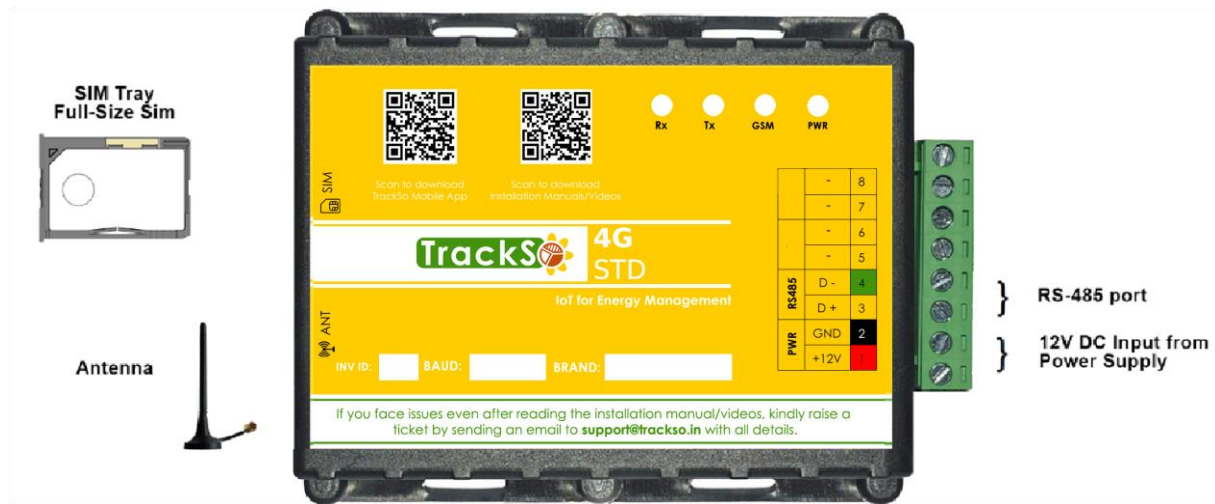

Installation Location

In order to keep the device away from damage and working normally, following conditions should be met when choosing the installation place.

- For outdoor installation or operation under adverse conditions the device must be mounted in an additional casing that meets the requirements of the required protection class.
- Direct sunshine, vibration and pressure should be avoided.
- Area for connecting cables should face downwards
- Hang the Data Logger kit (IP65 box supplied) on the wall instead of drilling in the box.

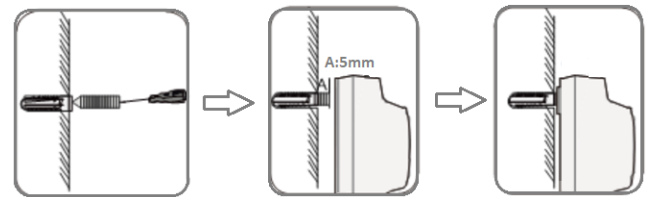

Power Supply

1. Be sure that the power supply voltage remains within the allowed range to avoid any damage to device.
2. Connecting the supply voltage to the RS485 port will damage the data logger and other connected equipment's.
3. Install **Power Backup (UPS)** for continuous working of Data Logger as per site requirements. Sample Specs (12V DC /2A)- <https://amzn.to/2NnFmMy>
4. **Overvoltage Protection-** Its highly recommended to install of a surge protective device (SPD's etc.) to help to ensure an efficient level of device availability as per site requirements. More Details- <https://bit.ly/3pigZy0>

Modbus RS485 Wiring

1. **RS485 Cable-** Using random cables instead of shielded twisted-pair of RS485 cables for communication connections affects the longevity of the solution. Kindly use proper shielded twisted-pair of RS485 Modbus cable for long-term error free usage. (**Example-** Belden #3106A)
2. Use 0.5 mm² RS485 cable for runs up to 300 meters and 0.75 mm² for runs up to 1200 meters
3. Run RS485 cable away from high voltage lines and earthing lines and in a separate conduit.
4. Always use a continuous length of wire, avoid combing wires to attain the needed length.
5. Use the wire trays for routing where possible
6. Avoid creating sharp bends in the wires
7. When there are external devices (such as weather monitoring system) connected to the Data Logger, add corresponding communication SPD according to onsite condition.

Internet Connectivity (SIM)

1. Push the yellow knob with a pin
2. SIM tray will come out from the device.
3. Put the SIM card in the tray as shown.
4. Push the tray back in the device.
5. Install the antenna provided inside the box



Monthly internet data consumption- The amount of data exchanged on the GPRS network varies depending on the configuration. However, the average consumption is around 50MB/month/slave for a data sending frequency of 10 mins.

If using a M2M sim with limited connectivity, kindly ensure the TrackSo Server URLs and IP's are whitelisted before visiting the site.

SMS Command to Verify Network Status

Network Status: Once you have inserted a working Simcard in logger with SMS & Internet Connectivity. Send the following SMS *2222#<Stat.gsm> on the simcard no. after 2 mins of inserting the sim in the data logger to verify if it was able to access internet.

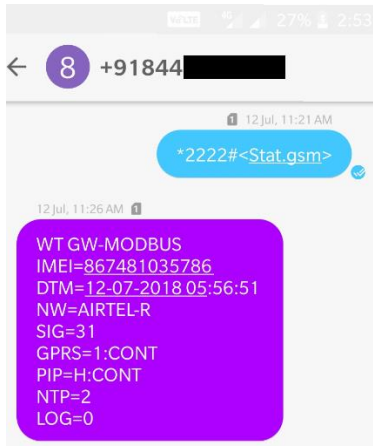

SMS Command (Case Sensitive)	*2222#<Stat.gsm>
IMEI	IMEI Number of the Data Logger (Available as Device Key on Platform)
DTM	UTC Date & Time available from Network Provider. IST = UTC +5:30 hours
NW	Network Name- Airtel-R , BSNL etc
SIGN	Signal Strength out of 31
GPRS	Availability of GPRS Connectivity from Network Provider <i>CONT- Connected, NC- Not Connected</i>
PIP	Internet Accessibility from your Sim Card <i>CONT- Connected, NC- Not connected</i>
LOG	Number of data points stored in devices in case of unavailability of internet

List of other SMS Commands Is available in Detailed Data Logger manual available on <https://trackso.in/datasheets/>

Understanding LED Details on Loggers

Use the below mentioned to identify the logger functionalities- Power/Network/Modbus status.



LED	NAME	DETAILS	
GREEN	POWER	Glows when 12V DC Input is supplied on Pin 1 & Pin 2 of Data Logger	
RED	GSM Network	LED Status	Connection Status
		Blinking Once at Every 0.5 Second	SIM Card not found or not Inserted Properly
		Blinking Once at Every 1 Second	Searching for GSM Network
		Blinking Once at Every 2 Seconds	SIM Registered on GSM Network
		Blinking twice at every 3 seconds	SIM Connected on GPRS
		Flashing 5 times and then pause	Sending data packet on TrackSo Portal
LED OFF	GSM Fault / No Power		
GREEN	COM TX	Data Logger requesting data from slave device	
YELLOW	COM RX	Data Logger receiving data from slave device	

To understand the LED Patterns via a demo video you can view the following video on YouTube.

Understanding LED patterns of TrackSo IoT Gateway- <https://www.youtube.com/watch?v=d9lwqba09CM>

RS485 Modbus Slave Connection Wiring

Connect required Inverters and Modbus RTU RS485 based equipment's to data logger Modbus.

- In the Inverter, open the Section which consists of MODBUS RS485 Ports
- Connect RS485+ or Data + pin inside the inverter with the D+ [pin 3] of TrackSo Data Logger
- Connect RS485- or Data - pin inside the inverter with the D- [pin 4] of TrackSo Data Logger
- For systems with multiple inverters, RS-485 network must be terminated at the last inverter by switching ON DIP switch for 120ohm resistor.

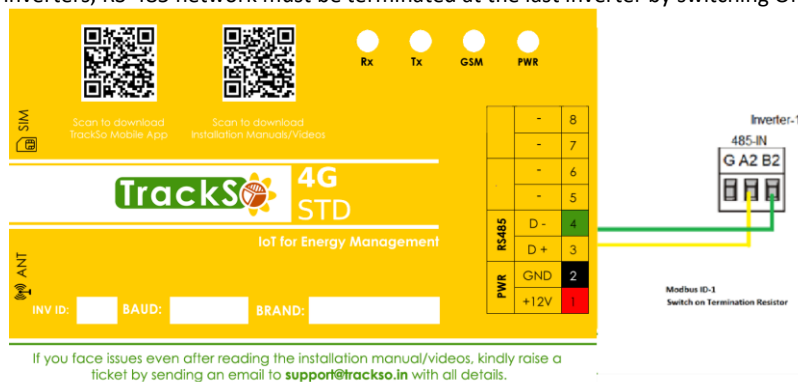

Note: At any one point of time only 1 Modbus Master- TrackSo Datalogger or Inverter Stick can be connected to Inverter for monitoring.

RS485 Modbus Slave Settings

Once all the required slaves (Inverters/meters etc) are connected.

- Set required Modbus Address or ID
- Set same Baud rate in all the connected Modbus Equipment's as mentioned on the Data Logger (Default- 9600bps)
- Set Date & Time in all the Inverters.
- If Inverter Supports Multiple Protocol- Set Modbus RTU protocol in all the Inverters.

Set Modbus Address

01

Set Baud Rate

9600

Communication Protocol

Modbus RTU

Date & Time

Set as per Actual

Detailed brand wise connection manuals and videos is available at below links:

Inverter/Meters



For Connections and Settings, refer to 'Installation Manual [Inv Brand]' on:
<https://trackso.in/trackso-installation-manuals/>

WMS (if any)



For physical installation and mounting of sensors, refer to 'Datasheet & Installation Guide – [sensor name]' on
<https://trackso.in/datasheets/>

Checking Connected Devices Status on Platform

1. Login to www.trackso.in via your Laptop with the email id associated with Data Logger
 - Dataloggers are linked to email ids provided by you while placing the order.
 - Note: No passwords are available with any Support/Sales Executives for any account. User is required to use "[Forgot Password](#)" option to get access to account created on trackso.in. No passwords will be shared over Email/Mobile.
2. Once logged in Navigate to Sites from Top Menu > Click on Your Site Name
3. Once you have reached your Site Overview > Click on Units
4. In Units section verify the Status of Units linked to your Data Logger IMEI (Device Key).
5. Update Mobile number of the SIM card installed in data logger in 'Device Number'

Unit Status	Inference
ON 3-Jan,21 17:02	The logger is able to receive data from the Slave device and continuously communicating with platform
OFF	The Logger is not communicating with the Platform. Check Power/Internet of the Logger
ON-ERR	This suggests logger is not able to get any response from slave (inverter/Meter/WMS/SMB) Modbus. Move your cursor on the unit status and it will show you the last event error details.
	In case of Error- No Response from Slave- Check Logger to Slave wiring & Modbus Settings

FAQ's- Frequently asked Questions & Important Links

- How can I create a user id password for my customer or other team members?
Login to your account on trackso.in and navigate to Configuration > User management and invite your customer or other team members by submitting their email ids.
- Platform Demo is available in form of short videos at this link- <https://trackso.in/platform-tutorials/>
Videos cover multiple topics such as How to Download Reports, Create Customized Dashboards, Create Daily Energy Notifications etc.
- Datasheets of all the supplied equipment's is available at this link- <https://trackso.in/datasheets/>
- Warranty Details- <https://trackso.in/warranty/>
- Service Form- <https://trackso.in/service-form/>

Customer Support

If you face trouble installing the system, kindly raise a support ticket by emailing on support@trackso.in or sending a WhatsApp message on +91-8800807765 (available Mon-Fri 10am-5pm) with the below mentioned details.

1. Site Name & Invoice No.
2. Mobile number of the SIM card installed in the data logger.
3. Photograph of the connection done on the data logger for power port.
4. Photograph of the connection done on the inverter for data communication (2 pictures- Data Logger side & inverter side)
5. Photograph of the inverter screen showing MODBUS settings [Slave ID, Baud Rate & Date & Time]
6. Photograph of the Weather Monitoring System connections with data logger (If installed)